

SKP 3000

Instructions for use

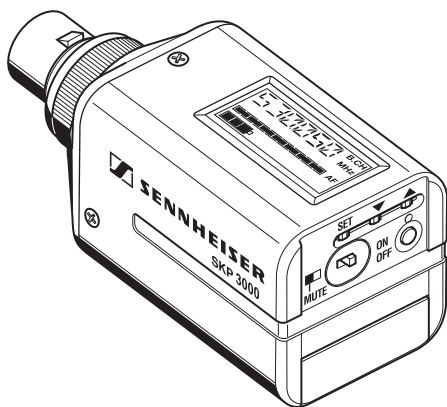

Thank you for choosing Sennheiser!

We have designed this product to give you reliable operation over many years. Over half a century of accumulated expertise in the design and manufacture of high-quality electro-acoustic equipment have made Sennheiser a world-leading company in this field.

Please take a few moments to read these instructions carefully, as we want you to enjoy your new Sennheiser product quickly and to the fullest.

Contents

Safety instructions	36
Delivery includes	36
The SKP 3000 plug-on transmitter	37
HiDyn <i>plus</i> noise reduction	38
Operating controls	40
Indications and displays	41
Putting the SKP 3000 into operation	43
The operating menu	46
Working with the operating menu	48
Operating menu of the plug-on transmitter	50
Adjustment tips for the operating menu	52
Troubleshooting	56
Care and maintenance	58
Specifications	59
Accessories	61

Safety instructions

Never open an electronic unit! If units are opened by customers in breach of this instruction, the warranty becomes null and void.

Use the SKP 3000 plug-on transmitter in dry rooms only.

Delivery includes

- 1 SKP 3000 plug-on transmitter
- 2 AA size batteries, 1.5 V
- Instructions for use

The SKP 3000 plug-on transmitter

The SKP 3000 transmitter permits wireless transmission with studio-quality sound. The use of further optimised PLL and microprocessor technology and the *HiDyn plus* noise reduction system ensure interference-free transmission.

The transmitter can be supplied in nine frequency ranges within the UHF band and with a frequency grid of 5 kHz. Please note: Frequency usage is different for each country. Your Sennheiser agent will have all the necessary details on the available legal frequencies for your area.

Range	Frequency range	Range	Frequency range
A	518 to 554 MHz	F	556 to 592 MHz
B	626 to 662 MHz	G	576 to 612 MHz
C	740 to 776 MHz	H	670 to 706 MHz
D	786 to 822 MHz	I	696 to 732 MHz
E	830 to 866 MHz		

The plug-on transmitter has two channel banks with up to 20 switchable channels each.

The channels of the channel bank "FIX" (Fixed Bank) are factory-preset to customer specific transmission frequencies. These transmission frequencies cannot be changed but have been preset so that e.g. country-specific regulations on frequency usage are taken into account.

The channel bank "VAR" (Variable Bank) allows you to store your selection of transmission frequencies that are freely selectable within the preset frequency range. Please note,

however, that the channel bank "VAR" is factory-preset to the same frequencies as the channel bank "FIX".

The transmitter can be combined with the rack-mount and bodypack receivers of the 3000 and 5000 series (e.g. EM 3252, EM 3032, EM 3031, EK 3041, EM 1046).

The balanced XLR input allows the connection of

- dynamic microphones,
- condenser microphones with internal power supply and
- condenser microphones that require 48 V phantom powering.

HiDyn *plus* noise reduction

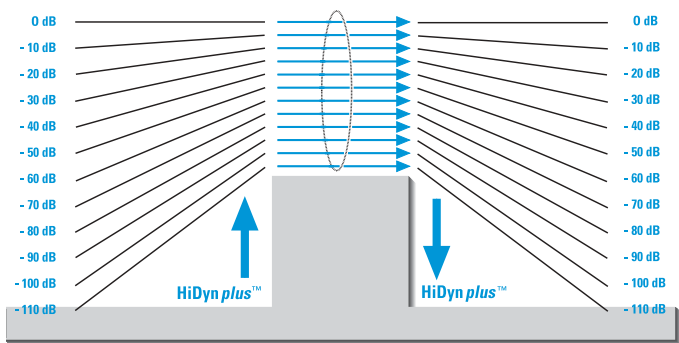

This transmitter is equipped with *HiDyn plus* the Sennheiser noise reduction system that reduces RF interference. It increases the signal-to-noise ratio in wireless audio transmission to more than 114 dB.

HiDyn *plus* is a wideband compander system which compresses the audio signal in the transmitter in a ratio of 2:1 (related to dB). In the receiver the signal is expanded in an identical and opposite way in a 1:2 ratio to restore the original signal. HiDyn *plus* has been specially developed for high quality radiomicrophone systems.

Note:

Only transmitters and receivers that are equipped with HiDyn *plus* can work correctly with each other. If non HiDyn *plus* equipment was mixed with HiDyn *plus*, the dynamic range would be drastically reduced and the transmission would sound blunt and flat. HiDyn *plus* is permanently active and cannot be switched off.

Operating controls

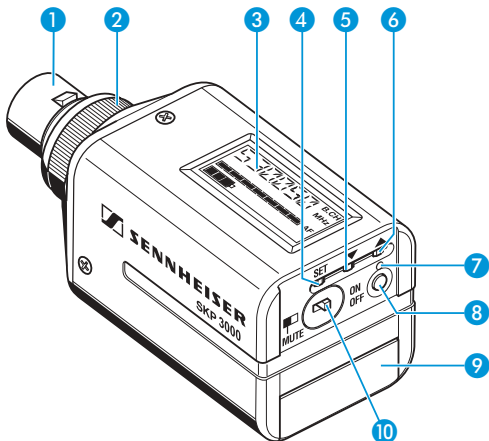

- 1 Microphone input, XLR-3F socket (balanced)
- 2 Mechanical locking ring of XLR-3 socket
- 3 LC display
- 4 SET button
- 5 ▼ button (DOWN)
- 6 ▲ button (UP)
- 7 Red LED for operation and battery status indication (ON/LOW BAT)
- 8 ON/OFF button
(serves as the ESC (cancel) key in the operating menu)
- 9 Battery compartment cover
- 10 MUTE switch

Indications and displays

LC display panel

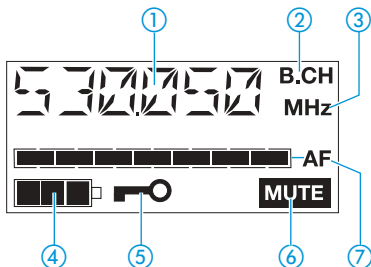

- ① Alphanumeric display
- ② "B.CH" – appears when the channel bank and the channel number are displayed
- ③ "MHz" – appears when the frequency is displayed
- ④ Battery status display
- ⑤ Lock mode icon
(lock mode is activated)
- ⑥ "MUTE" display
(audio input is muted)
- ⑦ 7-step level display for audio signal "AF"
with "Peak-Hold" function

Operation and battery status indication

The red LED (LOW BAT/ON) ⑦ provides information on the current operating state of the plug-on transmitter:

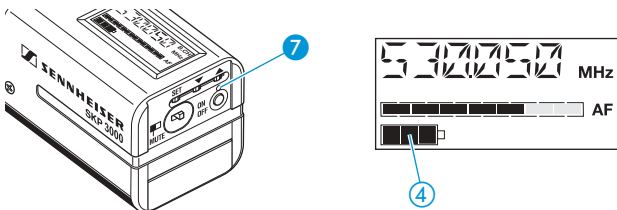

Red LED lit up: The plug-on transmitter is switched on. The capacity of the batteries/BA 2015 accupack is sufficient.

Red LED flashing: The batteries are/the BA 2015 accupack is going flat (LOW BAT)!

In addition, the 4-step battery status display ④ on the display panel provides information on the remaining battery/BA 2015 accupack capacity:

3 segments: capacity approx. 100 %

2 segments: capacity approx. 70 %

1 segment: capacity approx. 30 %

Battery icon flashing: LOW BAT

Display backlighting

After pressing a button, the display remains backlit for approx. 15 seconds.

Putting the SKP 3000 into operation

Inserting and replacing the batteries

For powering the plug-on transmitter, you can either use two 1.5 V AA size batteries or the rechargeable Sennheiser BA 2015 accupack.

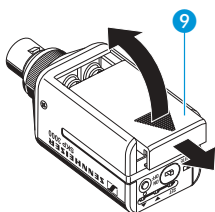

- ▶ Slide the battery compartment cover 9 in the direction of the embossed arrow until it clicks audibly and open the cover.

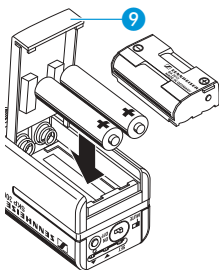

- ▶ Insert the two batteries or the BA 2015 accupack as shown below. Please observe correct polarity when inserting the batteries/accupack.
- ▶ Close the battery compartment. The battery compartment cover 9 locks into place with an audible click.

Note:

For accupack operation of the transmitter, only use the BA 2015 accupack in order to ensure optimum operational reliability. Batteries and rechargeable battery cells have different discharging curves. The transmitter is able to identify the BA 2015 accupack and to use its capacity to the

full. The transmitter adapts the battery status display according to the type of power supply used (batteries or accupack) and ensures correct transmission of battery status information to the receivers. Individual rechargeable battery cells will not be identified as accupacks.

Plugging the plug-on transmitter onto a microphone

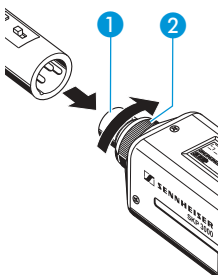

- ▶ Unscrew the locking ring ② by turning it fully counter-clockwise (XLR-3 socket is unlocked).
- ▶ Plug the transmitter's XLR-3F socket ① onto the microphone's XLR-3M socket.
- ▶ Tighten the locking ring ② by turning it clockwise (in the direction of the arrow).

Note:

The transmitter uses the microphone body as an antenna – therefore only microphones with a metal casing should be used for best signal transmission.

Switching the plug-on transmitter on/off

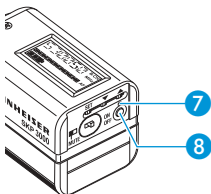

- ▶ Press the **ON/OFF** button **8** to switch the transmitter on. The red LED **7** lights up.
- ▶ To switch the transmitter off, press the **ON/OFF** button **8** until "OFF" appears on the display. The red LED **7** goes off.

Note:

Within the operating menu, the **ON/OFF** button serves as the ESC (cancel) key (see "Exiting the operating menu" on page 49).

Remove the batteries or the accupack when the transmitter will not be used for extended periods of time.

Muting the plug-on transmitter

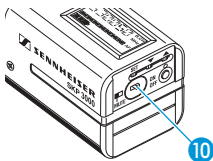

The transmitter has a **MUTE** **10** switch that noiselessly mutes the audio signal without switching the transmitter off. The "MUTE" display appears on the display panel.

Activating/deactivating the lock mode

The lock mode prevents that the transmitter is accidentally programmed or switched off during operation (see "Activating/deactivating the lock mode – LOCK" on page 55).

The operating menu

The buttons

Buttons	Mode	To...
ON/OFF	Standard display	switch the transmitter on and off
	Operating menu	cancel the entry and return to the standard display
	Setting mode	cancel the entry and return to the standard display
SET	Standard display	get into the operating menu
	Operating menu	get into the setting mode of the selected menu
	Setting mode	store the settings and return to the top menu level
▲/▼	Standard display	without function
	Operating menu	change to the previous menu (▲) or change to the next menu (▼)
	Setting mode	adjust the setting of the selected menu: option (▲/▼)

Overview of menus

Display	Function of the menu
BANK	Switching between channel banks
CHAN	Switching between the channels in a channel bank
TUNE	Setting a transmission frequency for the channel bank "U" (user bank)
SENSIT	Adjusting the sensitivity (AF)
PHANTO	Switching the phantom powering on/off
DISPLY	Selecting the standard display
NAME	Entering a name
LOCK	Activating/deactivating the lock mode
EXIT	Exiting the operating menu and returning to the standard display

Working with the operating menu

By way of example of the "TUNE" menu, this section describes how to use the operating menu.

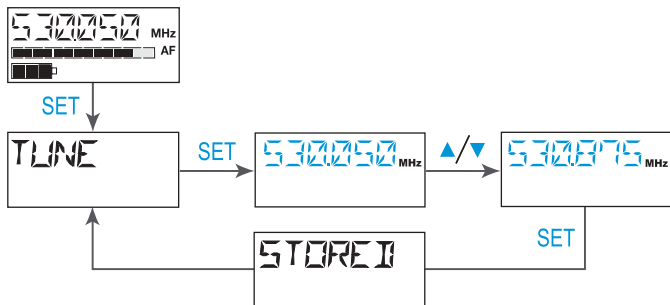

After switching the transmitter on, the standard display is shown on the display panel.

Getting into the operating menu

- ▶ Press the SET button to get from the standard display into the operating menu. The last selected menu flashes on the display.

Selecting a menu

- ▶ Press the ▲/▼ buttons to select a menu.
- ▶ Press the SET button to get into the setting mode of the selected menu. The current setting that can be adjusted flashes on the display.

Adjusting a setting

- ▶ Press the ▲/▼ buttons to adjust the setting. By briefly pressing the ▲/▼ buttons, the display jumps either forwards or backwards to the next setting. In the “CHAN”, “TUNE” and “NAME” menu, the ▲/▼ buttons feature a “fast search” function. If you hold down a button, the display cycles continuously, allowing you to get fast and easily to your desired setting.

Storing a setting

- ▶ Press the SET button to store the setting. “STORED” appears on the display, indicating that the setting has been stored. The display then returns to the top menu level. With most menus, new settings become effective immediately without having to be stored. An exception are the “BANK”, “CHAN” and “TUNE” menus. With these menus, new settings only become effective after they have been stored (“STORED” appears on the display, indicating that the setting has been stored).

Exiting the operating menu

- ▶ Select the “EXIT” menu to exit the operating menu and to return to the standard display. When in the operating menu, briefly pressing the ON/OFF button will cancel your entry (ESC function) and return you to the standard display with the last stored settings.

Operating menu of the plug-on transmitter

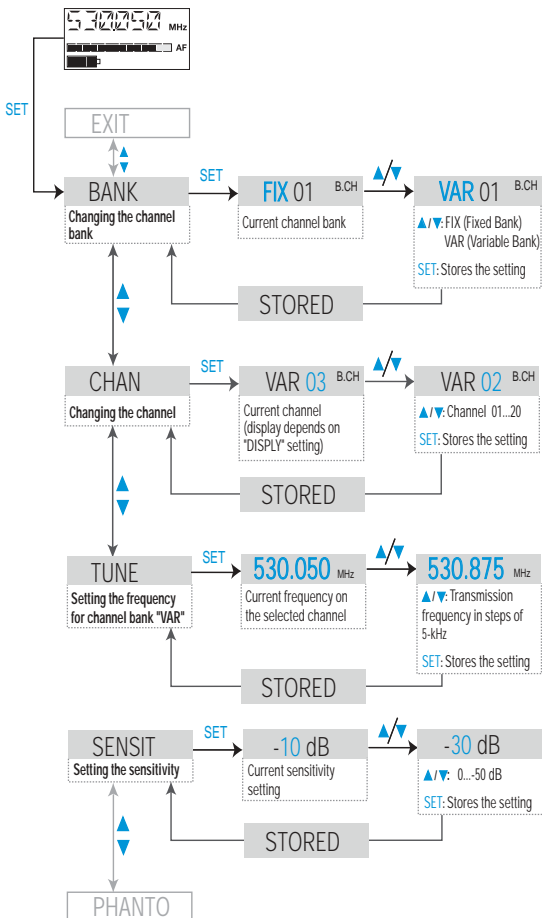

Adjustment tips for the operating menu

Switching between channel banks – BANK

Via the “**BANK**” menu, you can switch between the two channel banks. The channels of the channel bank “**FIX**” (Fixed Bank) are factory-preset to customer specific transmission frequencies. These frequencies cannot be changed.

The channel bank “**VAR**” (Variable Bank) allows you to store your selection of transmission frequencies that are freely selectable within the preset frequency range. Please note that the channel bank “**VAR**” is factory-preset to the same frequencies as the channel bank “**FIX**”.

When switching from one channel bank to the other, the channel with the lowest channel number is automatically displayed.

Switching between the channels in a channel bank – CHAN

Via the “**CHAN**” menu, you can switch between the up to 20 channels in a channel bank.

Selecting the frequencies to be stored in the channel bank “**VAR**” – TUNE

Via the “**TUNE**” menu, you can select the frequencies to be stored in the channel bank “**VAR**” (Variable Bank).

When you select the “**TUNE**” menu, the channel set briefly appears on the display and then the last frequency stored is displayed. When you have selected the channel bank “**FIX**” and then select the “**TUNE**” menu, the transmitter automatically switches to channel 01 of the channel bank “**VAR**” and “**VAR**” briefly appears on the display.

The frequencies are tunable in 5-kHz steps within a switching bandwidth of 36 MHz max.

Note:

When operating a multi-channel system, make sure to only use frequencies that are intermodulation-free.

Adjusting the sensitivity – SENSIT

Via the “SENSIT” menu, you can adjust the transmitter’s input sensitivity.



The sensitivity is correctly adjusted when the level display for audio signal “AF” ⑦ shows full deflection only during the loudest passages.

For monitoring the adjusted sensitivity, the transmitter’s level display for audio signal “AF” ⑦ always indicates the audio level – even if the transmitter is muted.

In order to be able to use highly sensitive directional condenser microphones, the plug-on transmitter offers a sensitivity range extended by 20 dB.

The following figures are a guide to the best settings:

	dynamic microphones	directional condenser microphones
Loud music/vocals	–30 to –20 dB	–50 to –40 dB
Presentations	–20 to –10 dB	–40 to –30 dB
Interviews	–10 to 0 dB	–30 to –20 dB

Switching the phantom powering on/off – PHANTO

The plug-on transmitter can supply condenser microphones without internal power supply with 48 V phantom powering (P 48). The phantom powering can be switched on or off via the “PHANTO” menu. Please note: Dynamic microphones can be operated in phantom powering mode without harm. However, if no condenser microphone module is being used, you should switch off the phantom powering. With the phantom powering switched on, the operating time of the batteries or the BA 2015 accupack will be reduced.

Selecting the standard display – DISPLY

Via the “DISPLY” menu, you can select the standard display:



Entering a name – NAME

Via the “NAME” menu, you can enter a freely selectable name for the transmitter. The name can be displayed on the standard display and can consist of up to six characters such as:

- letters (without pronunciation marks),
- numbers from 0 to 9,
- special characters e. g. () - . _ and spaces.

To enter a name, proceed as follows:

- ▶ Press the **SET** button to get into the setting mode of the “NAME” menu. The first segment starts flashing on the display.

- ▶ With the ▲/▼ buttons you can now select a character. By briefly pressing a button, the display jumps either forwards or backwards to the next character. If you hold down a button, the display starts cycling continuously.
- ▶ Press the SET button to change to the next segment and select the next character.
- ▶ Have you entered the name completely? Press the SET button to store your setting and to return to the top menu level.

Activating/deactivating the lock mode – LOCK

Via the “LOCK” menu, you can activate or deactivate the lock mode. The lock mode prevents that the transmitter is accidentally programmed or switched off during operation.

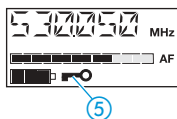

The lock mode icon ⑤ on the display indicates that the lock mode is activated.

- ▶ To deactivate the lock mode, first press the SET button and then press the ▲/▼ buttons to select “LOC.OFF”. If you confirm your selection by pressing the SET button, the buttons can be operated as usual.

Exiting the operating menu – EXIT

Via the “EXIT” menu, you can exit the operating menu and return to the standard display.

Troubleshooting

Error checklist

Problem	Possible cause	Possible solution
No operation indication	Batteries are flat or inserted incorrectly, accupack is flat	Replace the batteries or check if they are inserted correctly or recharge the accupack
Receiver: No RF signal	Transmitter and receiver are not on the same channel	Set transmitter and receiver to the same channel
	Transmitter is out of range	Check the squelch threshold setting or reduce the distance between transmitter and receiving antenna
Receiver: RF signal available, no audio signal	Transmitter is muted (MUTE)	Deactivate the muting function
	Receiver's squelch threshold is adjusted too high	Reduce the squelch threshold
Audio signal has a high level of background noise	Transmitter sensitivity is adjusted too low	see "Adjusting the sensitivity – SENSIT" on page 53
	Receiver's AF output level is adjusted too low	Increase the audio output level

Audio signal is distorted	Transmitter sensitivity is adjusted too high	see "Adjusting the sensitivity – SENSIT" on page 53
	Receiver's AF output level is adjusted too high	Reduce the AF output level

If problems occur that are not listed in the above table or if the problems cannot be solved with the proposed solutions, please contact your local Sennheiser agent for assistance.

Tips for optimum reception

- Transmission range depends to a large extent on location and can be up to 150 m. There should be a "free line of sight" between transmitting and receiving antennas.
- To avoid overmodulating the receiver, observe a minimum distance of 5 m between transmitting and receiving antennas.

Tips for multi-channel operation

- When operating a multi-channel system, make sure to only use frequencies that are intermodulation-free.

Care and maintenance

Use a slightly damp cloth to clean the transmitter from time to time.

Note:

Do not use any cleansing agents or solvents.

Specifications

RF characteristics

Modulation	wideband FM
Frequency ranges	518–554, 626–662, 740–776, 786–822, 830–866, 556–592, 576–612, 670–706, 696–732 MHz
Transmission frequencies	1 channel bank with up to 20 channels (frequencies according to customer specifications) 1 channel bank with up to 20 freely selectable channels (tunable in steps of 5 kHz)
Switching bandwidth	36 MHz
Nominal/peak deviation	±40 kHz / ±56 kHz
Frequency stability	≤±10 ppm
RF output power at 50 Ω	typ. 30 mW

AF characteristics

Noise reduction system	Sennheiser <i>HiDyn plus</i>
AF frequency response	60–20,000 Hz
S/N ratio (at 1 mV and peak deviation)	≥ 114 dB(A) (at the receiver output)

Nominal input sensitivity (at nominal deviation and 1 kHz)	0 dB, 22 mV -10 dB, 70 mV -20 dB, 220 mV -30 dB, 700 mV -40 dB, 2,0 V -50 dB, 2,0 V (limited by a protective circuit)
Max. input voltage (at peak deviation)	2.8 V _{rms}
THD (at nom. deviation and 1 kHz)	≤0,3 %

Overall unit

Power supply	2 AA size batteries, 1.5 V or BA 2015 accupack	
Microphone phantom powering	48 V ±4 V (at 2 mA)	
Max. power consumption:		
• at nominal voltage (2.4 V)	approx. 190 mA	
• with switched-on phantom powering	approx. 280 mA	
• with switched-off transmitter	≤50 µA	
Operating time:	Battery	BA 2015
• with switched-off phantom powering	> 8 h	> 8 h
• with switched-on phantom powering	> 5 h	> 5 h
Temperature range	-10 °C to +55 °C	
Dimensions [mm]	105 x 43 x 43	
Weight (incl. batteries)	approx. 195 g	

Accessories

BA 2015

L 2015

POP 1

Accupack

Charger for BA 2015 accupack

Plug-on pouch

SENNHEISER electronic GmbH & Co. KG

Am Labor 1, D-30900 Wedemark

erklären, dass die Produkte declare that these devices
déclarons que ces appareils declaramos que estos aparatos
dichiaro che questi apparecchi verklaren, dat deze toestelen

SKP 3000

Plug-On-Transmitter

den einschlägigen Anforderungen der EG-Richtlinie 89/336/EEC bzw. der R&TTE-Direktive 1999/5/EC entsprechen.

Zur sachgemäßen Umsetzung der in den EG-Richtlinien genannten Anforderungen wurden folgende Normen herangezogen:

conform to the basic requirements of EEC Directive 89/336/EEC resp. R&TTE Directive 1999/5/EC.

To effect correct application of the requirements stated in the EEC Directives, the following standards were consulted:

sont conformes aux prescriptions fondamentales dans la Directive de la CEE 89/336/EEC or la Directive R&TTE 1999/5/EC.

Pour mettre en pratique dans la règle de l'art les prescriptions des Directives de la CEE, il a été tenu compte des normes suivantes:

complen los requerimientos básicos de la normativa de la CEE 89/336/EEC resp. de la normativa R&TTE 1999/5/EC.

Con il fin de realizar de forma adecuada los requerimientos referidos en las normativas de la CEE fueron consultadas las siguientes normativas:

sono conformi alla normativa 89/336/EEC resp. alla normativa R&TTE 1999/5/EC.

Per un'opportato risconto nell'ambito della normativa CEE sono state consultate le seguenti normative:

evereenkomt met de basiseisen van de EG-Richtlijn 89/336/EEC resp. de EG-Richtlijn 1999/5/EC.

Om de eisen, die in de EG-Richtlijnen vermeld zijn, in juiste vorm om te zetten, zijn van volgende normen gebruik gemaakt:

ETS 300 445

ETS 300 422

Wedemark, Oct, 2003



Klaus Willemsen,
Key Projects,
Product Marketing

Bemerkung:

Vor Inbetriebnahme sind die jeweiligen länderspezifischen Vorschriften zu beachten!

Important:

Before putting the device into operation, please observe the respective country-specific regulations!

Important:

Avant d'utiliser l'appareil, veuillez observer les dispositions légales en vigueur dans votre pays.

Nota:

Prima della messa in funzione seguite le prescrizioni vigenti nel paese nel quale viene utilizzato!

Observación:

iAnterior a la puesta en funcionamiento deberán observarse las correspondientes ordenanzas nacionales!

Opmerking:

Voor inbedrijfstelling dient u de afzonderlijke landspecifieke voorschriften in acht te nemen!

ENGLISH

The guarantee period for this Sennheiser product is 24 months from the date of purchase. Excluded are accessory items, rechargeable or disposable batteries that are delivered with the product; due to their characteristics these products have a shorter service life that is principally dependent on the individual frequency of use.

The guarantee period starts from the date of original purchase. For this reason, we recommend that the sales receipt be retained as proof of purchase. Without this proof (which is checked by the responsible Sennheiser service partner) you will not be reimbursed for any repairs that are carried out.

Depending on our choice, guarantee service comprises, free of charge, the removal of material and manufacturing defects through repair or replacement of either individual parts or the entire device. Inappropriate usage (e.g. operating faults, mechanical damages, incorrect operating voltage), wear and tear, force majeure and defects which were known at the time of purchase are excluded from guarantee claims. The guarantee is void if the product is manipulated by non-authorised persons or repair stations.

In the case of a claim under the terms of this guarantee, send the device, including accessories and sales receipt, to the responsible service partner. To minimise the risk of transport damage, we recommend that the original packaging is used. Your legal rights against the seller, resulting from the contract of sale, are not affected by this guarantee.

The guarantee can be claimed in all countries outside the U.S. provided that no national law limits our terms of guarantee.



Sennheiser electronic GmbH & Co. KG
30900 Wedemark, Germany
Phone +49 (5130) 600 0
Fax +49 (5130) 600 300
www.sennheiser.com

Printed in Germany

Publ. 04/04

92174/A01